

Select Points for Preparing SYFOVRE for Ophthalmic Intravitreal Injection¹



Remove the carton from the refrigerator. The vial should be kept in the original carton at room temperature (20°C to 25°C or 68°F to 77°F) for at least 15 minutes prior to injection, but no longer than 8 hours. Fill the syringe immediately prior to the injection. **Do not** shake the vial. Aqueous solution should appear clear/colorless to light yellow.



Do not shake the vial.
Do not tap the syringe to remove air bubbles. While maintaining the filter needle within the vial, invert the syringe and move the plunger down and up until bubbles move to the top.



SYFOVRE should be administered using either a sterile ½ inch 29-gauge thin-wall injection needle with **Luer-lock** hub or a sterile ½ inch 27-gauge needle with **Luer-lock** hub. Use of a smaller diameter injection needle may result in increased injection forces and/or increased injection time.

See details and additional information below for the recommended preparation of SYFOVRE for administration, and the full [Prescribing Information](#), including Injection Procedure, section 2.4.

INDICATION

SYFOVRE[®] (pegcetacoplan injection) is indicated for the treatment of geographic atrophy (GA) secondary to age-related macular degeneration (AMD).

IMPORTANT SAFETY INFORMATION

CONTRAINDICATIONS

- SYFOVRE is contraindicated in patients with ocular or periocular infections, in patients with active intraocular inflammation, and in patients with hypersensitivity to pegcetacoplan or any of the excipients in SYFOVRE. Systemic hypersensitivity reactions (e.g., anaphylaxis, rash, urticaria) have occurred.

Please see Important Safety Information for SYFOVRE throughout this document.

Preparation for Administration

STEP 1

Gather the supplies needed:

Included in SYFOVRE carton:

- One SYFOVRE vial

Additional supplies needed:

- Intravitreal Injection Kit (provided by Apellis and will accompany the SYFOVRE carton):
 - One sterile 5-micron filter needle
 - One sterile ½ inch: 29-gauge thin-wall injection needle with Luer-lock hub or a 27-gauge needle with Luer-lock hub (not included)

Note: Increased injection forces and/or increased injection time could be experienced if a smaller diameter injection needle is used (eg, 30-gauge)

- One sterile 1-mL Luer-lock syringe with a 0.1 mL dose mark
- Alcohol swab

SYFOVRE should be removed from the refrigerator and kept in the original carton at room temperature (20°C to 25°C or 68°F to 77°F) for at least 15 minutes prior to injection, but no longer than 8 hours.

Use aseptic technique to carry out the following preparation steps:

STEP 2

Remove the flip-off cap from the vial (**see Figure 1a**) and clean the vial septum with an alcohol swab and wait for the alcohol to dry out (**see Figure 1b**).

Figure 1a:



Figure 1b:



STEP 3

Attach the 5-micron filter needle onto a 1-mL Luer-lock syringe (**see Figure 2**) by twisting it onto the Luer-lock syringe tip.

Figure 2:

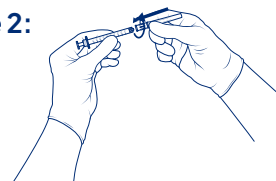

IMPORTANT SAFETY INFORMATION (CONT'D)

WARNINGS AND PRECAUTIONS

• Endophthalmitis and Retinal Detachments

- Intravitreal injections, including those with SYFOVRE, may be associated with endophthalmitis and retinal detachments. Proper aseptic injection technique must always be used when administering SYFOVRE to minimize the risk of endophthalmitis. Patients should be instructed to report any symptoms suggestive of endophthalmitis or retinal detachment without delay and should be managed appropriately.

STEP 4

Push the filter needle into the center of the vial septum until the needle is submerged in the drug product to prevent withdrawal of air (see **Figure 3a**). To withdraw the entire contents of the vial into the syringe, hold the vial at a slightly inclined position. Withdraw the drug product slowly to prevent air bubbles. Continue to tilt the vial during withdrawal keeping the bevel of the filter needle submerged in the liquid until all of the fluid is withdrawn from the vial (see **Figure 3b**). *Do not tap the syringe to remove air bubbles. While maintaining the filter needle within the vial, invert the syringe and move the plunger down and up until bubbles move to the top (see **Figure 3c**).

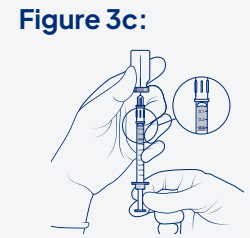
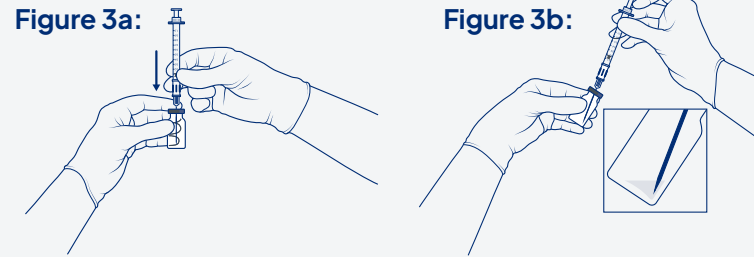
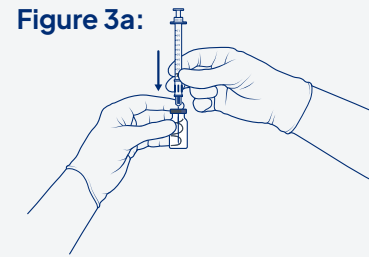

STEP 5

Using aseptic technique, disconnect the filter needle from the syringe and dispose of it. **Do not use the filter needle for injection.**

STEP 6

Aseptically and firmly attach the injection needle onto the 1-mL Luer-lock syringe (see **Figure 4**).

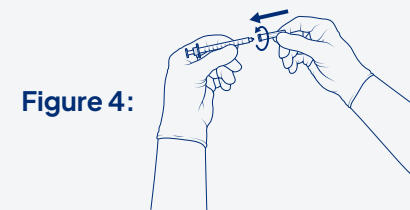

STEP 7

Check for air bubbles by holding the syringe with the needle pointing up. *Do not tap the syringe to remove air bubbles. If there are any air bubbles, remove the needle cap and with the needle end facing up gently advance the plunger to the 0.1 mL dose mark (see **Figure 5**). Only 0.1 mL (15 mg of SYFOVRE) should be administered to deliver a single dose. Any excess volume should be disposed.

The syringe is ready for injection. Ensure that the injection is given **immediately** after the preparation of the dose.

Please see full [Prescribing Information](#), including Injection Procedure, section 2.4.

IMPORTANT SAFETY INFORMATION (CONT'D)

WARNINGS AND PRECAUTIONS (CONT'D)

● Retinal Vasculitis and/or Retinal Vascular Occlusion

- Retinal vasculitis and/or retinal vascular occlusion, typically in the presence of intraocular inflammation, have been reported with the use of SYFOVRE. Cases may occur with the first dose of SYFOVRE and may result in severe vision loss. Discontinue treatment with SYFOVRE in patients who develop these events. Patients should be instructed to report any change in vision without delay.

● Neovascular AMD

- In clinical trials, use of SYFOVRE was associated with increased rates of neovascular (wet) AMD or choroidal neovascularization (12% when administered monthly, 7% when administered every other month and 3% in the control group) by Month 24. Patients receiving SYFOVRE should be monitored for signs of neovascular AMD. In case anti-Vascular Endothelial Growth Factor (anti-VEGF) is required, it should be given separately from SYFOVRE administration.

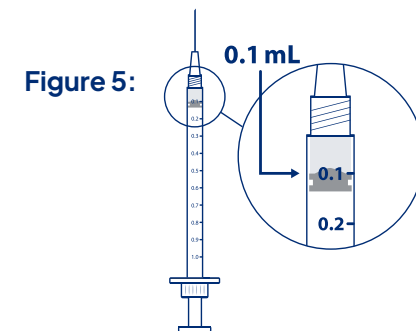

SYFOVRE Provides Flexible Dosing Schedules¹

SYFOVRE[®] (pegcetacoplan injection)
NDC Code: 73606-020-01

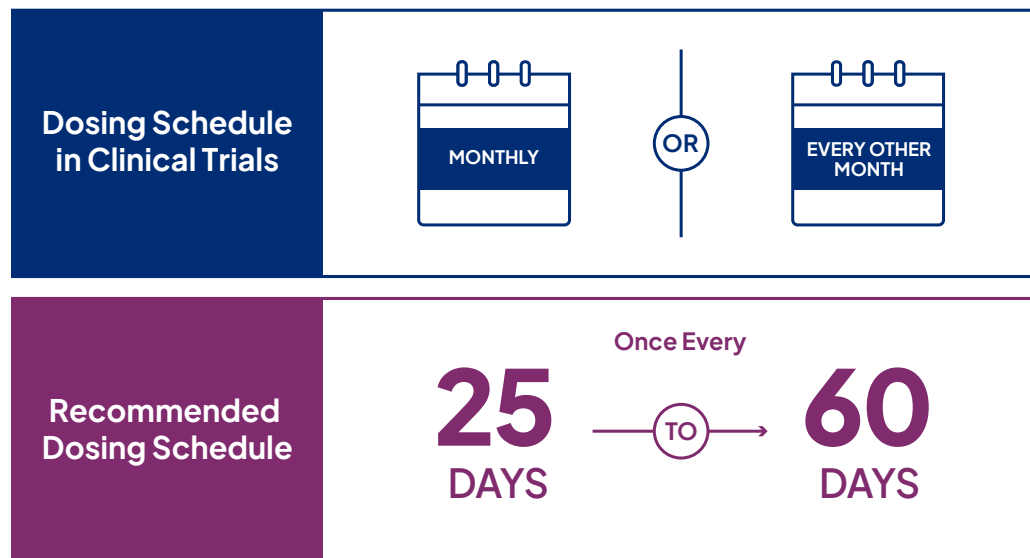

- SYFOVRE must be administered by a qualified physician¹
- The recommended dose for SYFOVRE is 15 mg (0.1 mL of 150 mg/mL solution) administered by intravitreal injection to each affected eye once every 25 to 60 days¹
- For additional information, see DOSAGE AND ADMINISTRATION, section 2, in the SYFOVRE full Prescribing Information¹

There were no clinically significant differences on the pharmacokinetics of SYFOVRE intravitreal administration based on age (60 to 97 years), gender, renal impairment, and hepatic function.¹

IMPORTANT SAFETY INFORMATION (CONT'D)

WARNINGS AND PRECAUTIONS (CONT'D)

- **Intraocular Inflammation**
 - In clinical trials, use of SYFOVRE was associated with episodes of intraocular inflammation including: vitritis, vitreal cells, iridocyclitis, uveitis, anterior chamber cells, iritis, and anterior chamber flare. After inflammation resolves, patients may resume treatment with SYFOVRE.
- **Increased Intraocular Pressure**
 - Acute increase in IOP may occur within minutes of any intravitreal injection, including with SYFOVRE. Perfusion of the optic nerve head should be monitored following the injection and managed as needed.

ADVERSE REACTIONS

- Most common adverse reactions (incidence $\geq 5\%$) are ocular discomfort, neovascular age-related macular degeneration, vitreous floaters, conjunctival hemorrhage.

Please see full [Prescribing Information](#) for more information.

Reference: 1. SYFOVRE (pegcetacoplan injection) [package insert]. Waltham, MA: Apellis Pharmaceuticals, Inc.; 2024.

Apellis

APELLIS[®], SYFOVRE[®] and their respective logos are registered trademarks of Apellis Pharmaceuticals, Inc.
©2025 Apellis Pharmaceuticals, Inc. 10/25 US-PEGGA-2200148 v6.0

SYFOVRE[®]
(pegcetacoplan injection)
15mg / 0.1mL